

## Product Specifications Sheet 产品规格表

**Model Description 型号规格:** 2895129/4420mAh/3.80V

No.	Item	Specification	Note
1	<b>Limited Charge Voltage</b> 充电限制电压	4.30V	
2	<b>Charge Voltage Upper Limit</b> 充电上限电压	4.35V	
3	<b>Nominal Voltage</b> 标称电压	3.80V	
4	<b>Minimum Capacity (Rated capacity)</b> 最小容量	4420mAh	Capacity measurement: Charge: Charge with 0.2C <sub>5Amin</sub> constant current to 4.30V, then 4.30V constant voltage charge until charge current is reduced to cut off limit 0.02 C <sub>5Amin</sub> . Discharge: 0.2 C <sub>5Amin</sub> discharge to 3.00V. 容量测试方法: 充电: 用 0.2 C <sub>5Amin</sub> 恒流充电至 4.30V, 保持 4.30V 恒压充电直到充电电流达到截止电流 0.02 C <sub>5Amin</sub> 。 放电: 0.2 C <sub>5Amin</sub> 恒流放电至 3.00V。 ※ Temperature: 25°C ± 2°C. ※ 环境温度: 25°C±2°C。
5	<b>Standard Charge Current</b> 标准充电电流	0.2 C <sub>5Amin</sub>	
6	<b>Max Charge Current</b> 最大充电电流	0.5C <sub>5Amin</sub>	
7	<b>Standard Discharge Current</b> 标准放电电流	0.2 C <sub>5Amin</sub>	
8	<b>Max Discharge Current</b> 最大放电电流	4420mA	
9	<b>Discharge Cut-off Voltage</b> 放电截止电压	3.00V	
10	<b>AC IR</b> 交流内阻	≤60mΩ	
11	<b>25±2°C Cycle Life</b> 常温循环寿命	≥500 Times	The capacity retention ≥ 80%
12	<b>Operation Temperature</b> 工作温度	-20°C~ +60°C	Discharge temperature range 放电温度范围
		0°C~ +45°C	Charge temperature range 充电温度范围

Above parameters are for reference only, AUCOPO may adjust the parameters in line with different application and project, please contact our sales for final specification.

以上所示参数仅供参考, 万宝公司可能根据应用和项目的具体要求调整以上参数, 请联系我们的销售人员确认最终的电芯参数规格。

地址: 福建省漳州市南靖县靖城镇 319 线 198 号 邮编:363601

Add: No.198, Highway 319, Jingcheng, Nanjing, Zhangzhou, Fujian Province, PR. China. Zip code:363601

电话(Tel):0596-7666111 传真(Fax):0596-7666222 网址(Website): www.aucopo.com

13	<b>Allowable Temperature and Humidity Range</b> 允许温度和湿度范围	Over 3 month : -20~27°C Less than 3 month:-20~35°C Less than 1 month: -20~45°C	Relative Humidity: ≤75%. Recommended storage at 30%~50%SOC. 相对湿度: ≤75%。 建议电芯在 30%~50%电量下储存。
14	<b>Weight</b> 重量	About 74.00g	

## Cell Dimensional Drawing 电芯尺寸图

Not in scale (未按比例)

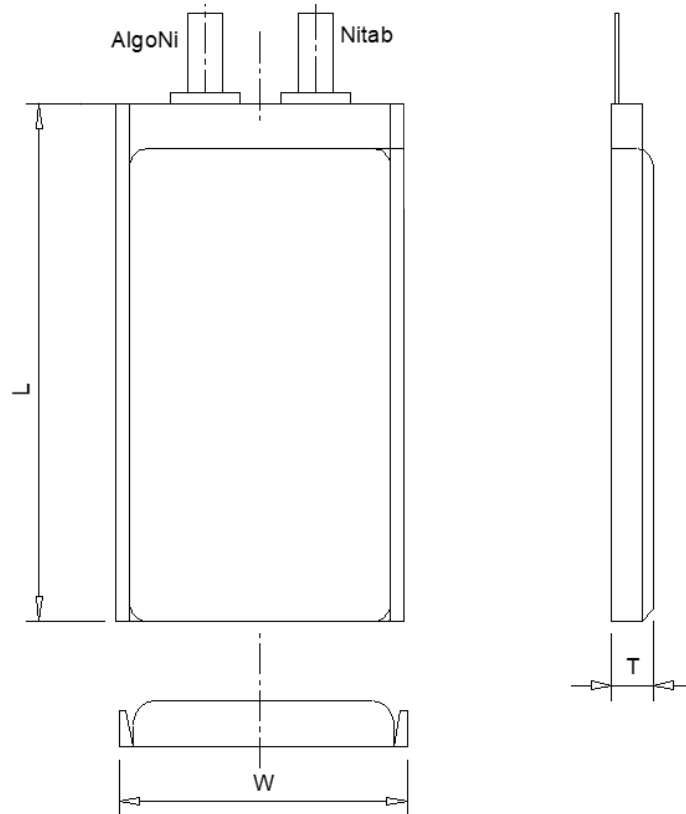

项目 Items	描述 Description	尺寸和规格 Dimension and Spec
T	Thickness 厚	2.90mm Max (Fresh) 3.13mm (After cycle swelling)
W	Width 宽	95.00mm Max
L	Length 长	129.00mm Max

Above parameters are for reference only, AUCOPO may adjust the parameters in line with different application and project, please contact our sales for final specification.

以上所示参数仅供参考，万宝公司可能根据应用和项目的具体要求调整以上参数，请联系我们的销售人员确认最终的电芯参数规格。

地址: 福建省漳州市南靖县靖城镇 319 线 198 号 邮编:363601

Add: No.198, Highway 319, Jingcheng, Nanjing, Zhangzhou, Fujian Province, PR. China. Zip code:363601

电话(Tel):0596-7666111 传真(Fax):0596-7666222 网址(Website): www.aucopo.com